

FL 8380 Compact Disc Changer

OWNER'S MANUAL

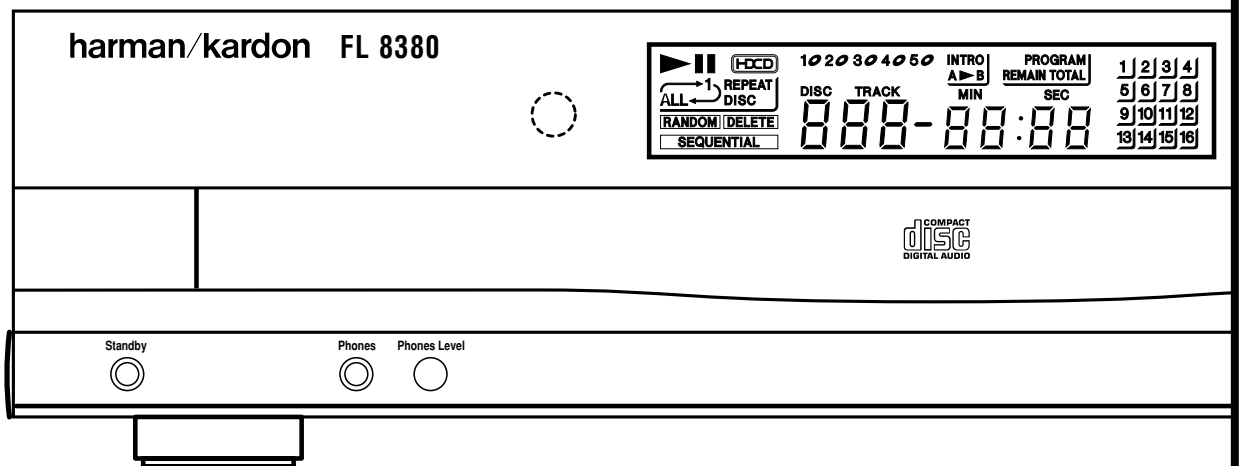

harman/kardon®

Power for the Digital Revolution™

Table of Contents

- 3 Introduction
- 4 Information
- 5 Front Panel Controls
- 6 Rear Panel Connections
- 7 Remote Control Functions
- 9 Installation and Connections
- 10 Operation
 - 10 Loading Discs
 - 10 Normal Play
 - 11 Random Play
 - 11 HDCD®
 - 11 Play Exchange
 - 11 Time Display
 - 11 Headphone Listening
- 12 Search
 - 12 Skip
 - 12 Intro Search
- 13 Programmed-Play Operation
 - 13 Programmed Play
 - 13 Checking Program Contents
 - 13 Clearing Programs
 - 13 Repeat Play
- 14 Troubleshooting Guide
- 15 Technical Specifications

Declaration of Conformity



We, Harman Consumer International
2, route de Tours
72500 Chateau-du-Loir
FRANCE

declare in own responsibility, that the product described
in this owner's manual is in compliance with technical
standards:

EN 60065:1993
EN 55013/A12/8.1994
EN 55022/5.1995
EN 55020/12.1994
EN 61000-3-2/4.1995
EN 61000-3-3/1.1995

Carsten Olesen
Harman Consumer International
Chateau-du-Loir, FRANCE. 09/00

Typographic Conventions

In order to help you use this manual with the remote control, front panel controls, rear panel connections and front panel displays, certain conventions have been used.

EXAMPLE – (bold type) indicates a specific remote control or front panel button, or rear panel connection jack

EXAMPLE – (OCR type) indicates a message that is visible on the front panel information display

EXAMPLE – (bold type) indicates a lit indicator in the front panel information display

1 – (number in a square) indicates a specific front-panel control

1 – (number in an oval) indicates a button or indicator on the remote

1 – (number in a circle) indicates a rear-panel connection

HDCD®, HDCD®, High Definition Compatible Digital® and Pacific Microsonics™ are either registered trademarks or trademarks of Pacific Microsonics, Inc., in the United States and/or other countries. HDCD system manufactured under license from Pacific Microsonics, Inc.

Introduction

Thank you for choosing Harman Kardon.





The FL 8380 CD changer is an exceptionally well-engineered product that offers high performance and ease of use.

We ask that you take a few minutes to read through this Owner's Manual to familiarize yourself with its controls and functions. This brief investment of time will yield dividends in the form of years of listening pleasure.

If you have any questions about this product – its installation or operation – please contact your dealer, who is your best local source of information.

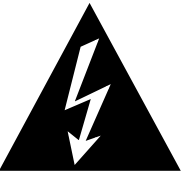
Description and Features

- **Five-Disc CD Changer with Advanced Programming Features That Create Play Lists of Selected Tracks, or Play Discs and Tracks in Random Order, for Hours of Uninterrupted Play**
- **Plays CD, CD-R and CD-RW Discs**
- **HDCD® Decoding Provides Superior Reproduction of All CDs, Whether HDCD-Encoded or Not. When HDCD-Encoded Discs Are Played, Special Circuitry Reveals Detail and Fidelity Not Possible in Ordinary CDs**
- **Coax Output for Direct Connection to Outboard Digital-to-Analog Converters or Digital Receivers**
- **Intro Search to Automatically Scan a Brief Portion of Each Track to Quickly Locate Your Favorite Selections**
- **Play-Exchange Feature Allows Discs to Be Changed While Another Disc is Playing**
- **Discrete Power On and Off Buttons on the Remote Control Facilitate Compatibility With Custom Home Control Systems**

	CAUTION RISK OF ELECTRIC SHOCK DO NOT OPEN	
<p>CAUTION: TO REDUCE THE RISK OF ELECTRIC SHOCK, DO NOT REMOVE COVER (OR BACK). NO USER-SERVICEABLE PARTS INSIDE. REFER SERVICING TO QUALIFIED SERVICE PERSONNEL.</p>		
	<p>The lightning flash with arrowhead symbol, within an equilateral triangle, is intended to alert the user to the presence of uninsulated "dangerous voltage" within the product's enclosure that may be of sufficient magnitude to constitute a risk of electric shock to persons.</p>	
<p>WARNING: TO REDUCE THE RISK OF FIRE OR ELECTRIC SHOCK, DO NOT EXPOSE THIS APPLIANCE TO RAIN OR MOISTURE.</p>		



Information

Important Safety Information

Verify Line Voltage Before Use

Your FL 8380 has been designed for use with 230-volt AC current. Connection to a line voltage other than that for which it is intended can create a safety and fire hazard, and may damage the unit.

If you have any questions about the voltage requirements for your specific model, or about the line voltage in your area, contact your dealer before plugging the unit into a wall outlet.

Do Not Use Extension Cords

We do not recommend that extension cords be used with this product. As with all electrical devices, do not run power cords under rugs or carpets or place heavy objects on them. Damaged power cords should be replaced immediately by an authorized service depot with cords meeting factory specifications.

Handle the AC Power Cord Gently

When disconnecting the power cord from an AC outlet, always pull the plug, never pull the cord. If you do not intend to use the unit for any considerable length of time, disconnect the plug from the AC outlet.

Do Not Open the Cabinet

There are no user-serviceable components inside this product. Opening the cabinet may present a shock hazard, and any modification to the product will void your guarantee. If water or any metal object such as a paper clip, wire or a staple accidentally falls inside the unit, disconnect it from the AC power source immediately, and consult an authorized service station.

CAUTION: The FL 8380 uses a laser system. To prevent direct exposure to the laser beam, do not open the cabinet enclosure or defeat any of the safety mechanisms provided for your protection. **DO NOT STARE INTO THE LASER BEAM.** To ensure proper use of this product, please read this owner's manual carefully and retain it for future use. Should the unit require maintenance or repair, please contact your local Harman Kardon service station. Refer servicing to qualified personnel only.

Installation Location

- To assure proper operation and to avoid the potential for safety hazards, place the unit on a firm and level surface. When placing the unit on a shelf, be certain that the shelf and any mounting hardware can support the weight of the product.
- Make certain that proper space is provided both above and below the unit for ventilation. If this product will be installed in a cabinet or other enclosed area, make certain that there is sufficient air movement within the cabinet.
- Do not place the unit directly on a carpeted surface.
- Avoid installation in extremely hot or cold locations, or an area that is exposed to direct sunlight or heating equipment.
- Avoid moist or humid locations.

Cleaning

When the unit gets dirty, wipe it with a clean, soft dry cloth. If necessary, wipe it with a soft cloth dampened with mild soapy water, then a fresh cloth with clean water. Wipe dry immediately with a dry cloth. NEVER use benzene, aerosol cleaners, thinner, alcohol or any other volatile cleaning agent. Do not use abrasive cleaners, as they may damage the finish of metal parts. Avoid spraying insecticide near the unit.

Moving the Unit

Before moving the unit, be certain to disconnect any interconnection cords with other components, and make certain that you disconnect the unit from the AC outlet.

IMPORTANT NOTE: To avoid damage to the FL 8380 which may not be covered by the warranty, be certain that all discs are removed from the unit before it is moved. Once the FL 8380 is installed, discs may be left in the unit when it is turned off, but the unit should NEVER be moved with discs left in either deck.

Important Information for the User

This equipment generates, uses and can radiate radio frequency energy and, if not installed and used in accordance with the instructions, may cause harmful interference to radio communication. However, there is no guarantee that harmful interference will not occur in a particular installation. If this equipment does cause harmful interference to radio or television reception, which can be determined by turning the equipment off and on, the user is encouraged to try to correct the interference by one or more of the following measures:

- Reorient or relocate the receiving antenna.
- Increase the distance between the equipment and receiver.
- Connect the equipment to an outlet on a circuit different from that to which the receiver is connected.
- Consult the dealer or an experienced radio/TV technician for help.

Unpacking

The carton and shipping materials used to protect your new CD changer during shipment were specially designed to cushion it from shock and vibration. We suggest that you save the carton and packing materials for use in shipping if you move, or should the unit ever need repair.

To minimize the size of the carton in storage, you may wish to flatten it. This is done by carefully slitting the tape seams on the bottom and collapsing the carton down to a more two-dimensional appearance. Other cardboard inserts may be stored in the same manner. Packing materials that cannot be collapsed should be saved along with the carton in a plastic bag.

If you do not wish to save the packaging materials, please note that the carton and other sections of the shipping protection are recyclable. Please respect the environment and discard those materials at a local recycling center.

Front Panel Controls

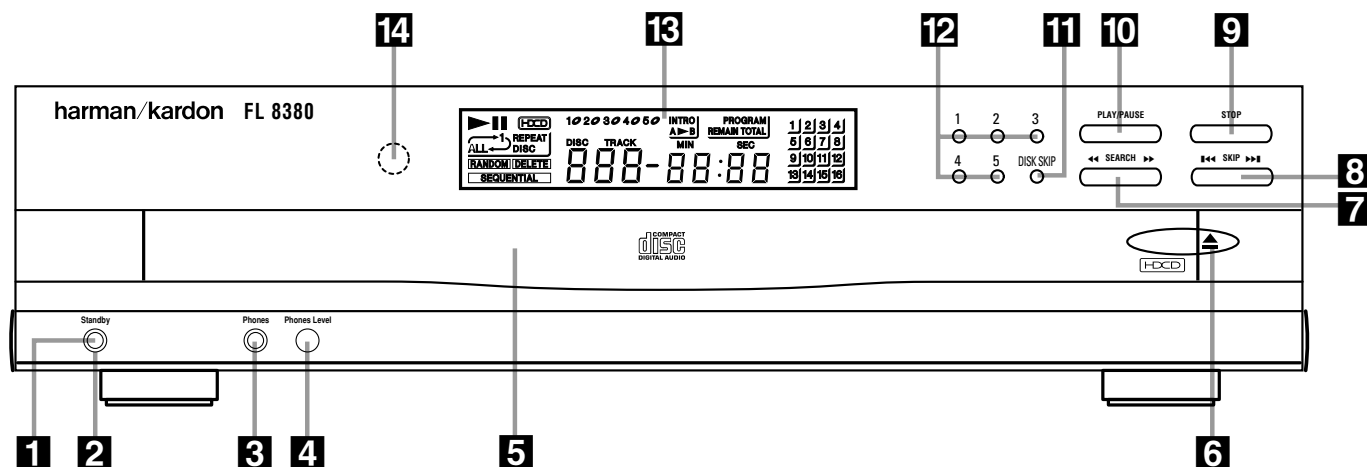

- 1** Standby
- 2** Status Mode Indicator
- 3** Headphones Jack
- 4** Headphones Level Control
- 5** CD Drawer

- 6** Open/Close Button
- 7** Search Button
- 8** Skip Button
- 9** Stop Button
- 10** Play/Pause Button

- 11** Disc Skip Button
- 12** Disc Select Button
- 13** Information Display
- 14** Remote Sensor

1 Standby: Press this switch to apply power to the FL 8380. Then the **Status-Mode Indicator 2** will turn green, the **Information Display 13** will illuminate and all trays will be checked automatically for discs. Press the switch again to turn the unit off; the **Status-Mode Indicator 2** will turn amber, indicating that the unit is in Standby. When the FL 8380 is connected to a switched AC outlet, such as those found on the back of many audio products, and the AC outlet will be turned on, the unit will turn to Standby mode only.

2 Status-Mode Indicator: When the FL 8380 is in the On mode, this indicator will glow green. When the unit is off, the indicator will glow amber, indicating that the unit is still connected to AC power.

3 Headphones Jack: Connect a set of standard headphones to this jack for private listening.

4 Headphones Level Control: Turn this knob to increase or decrease the volume level for headphones connected to the FL 8380's **Headphones Jack 3**. Note that changing this level will not change the sound level for the unit's main output, as that remains constant.

5 CD Drawer: This drawer holds the discs that will be played. Press the **Open/Close button 6** to open the drawer so that discs may be inserted.

6 Open/Close: Press this button to open or close the disc drawer. DO NOT push the drawer to close it or damage to the transport mechanism may result.

7 Search: Press one side of this button to search forward ►► or the other side of the button to search backwards ◀◀ through a disc to locate a particular portion of the disc being played.

8 Skip: Press the right side of this button to move to the next track ►► or the left side of the button to move back to the previous track ◀◀ on the disc being played.

9 Stop: Press this button to stop the disc currently being played. (See page 11 for more information.)

10 Play/Pause Button: Press this button to start the playback of a CD. If the CD drawer is open, pressing this button will automatically close the drawer. Press this button once during play to momentarily pause a disc. When the button is pressed again, the disc will resume play at the point it was paused.

11 Disc-Skip: Press this button to change to the next disc. If a disc position is empty, the FL 8380 will automatically search for the next position that contains a disc unless the disc drawer is open.

12 Disc-Select: Press one of these buttons to select the disc in a specific position in the CD drawer.

13 Information Display: This display provides details about the operation of the FL 8380.

14 Remote Sensor: The sensor behind this window receives commands from the remote control. Keep this area clear if you wish to use the FL 8380 with a remote control.

Rear Panel Connections

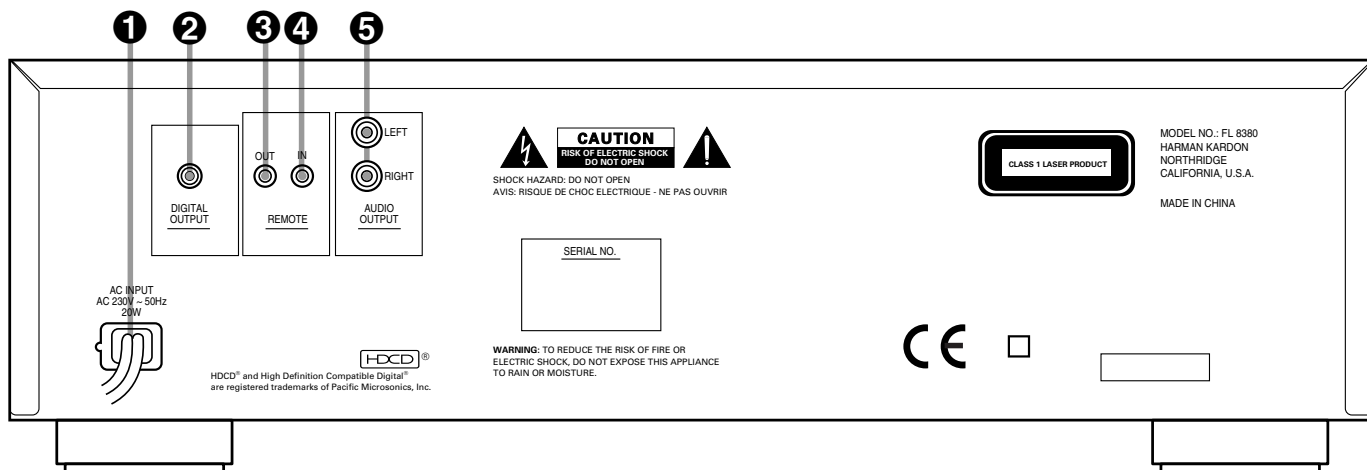

- ❶ AC Power Cord
- ❷ Coaxial Digital Output
- ❸ Remote Control Output

❶ AC Power Cord: Connect this plug to an AC outlet. If the outlet is switch controlled, make certain that the switch is in the ON position.

❷ Coaxial-Digital Output: Connect this jack to the coaxial-digital input of a digital audio/video receiver or an external digital-to-analog converter for direct access to the digital signals of the FL 8380. DO NOT connect this jack to the standard audio inputs of any device.

❸ Remote Control Output: Connect this jack to the input of another compatible Harman Kardon remote controlled device to have the remote sensor on the FL 8380 provide signals to other products.

- ❹ Remote Control Input
- ❺ Analog Audio Outputs

❹ Remote Control Input: Connect the output of a remote infrared sensor or the remote control output of another compatible Harman Kardon product. This will enable the remote control system to operate even when the front panel **Remote Sensor 14** is blocked. It will also allow use of the FL 8380 with optional, external control systems.

❺ Analog Audio Outputs: Connect these jacks to the analog CD audio inputs of your receiver, surround processor or preamplifier.

Remote Control Functions

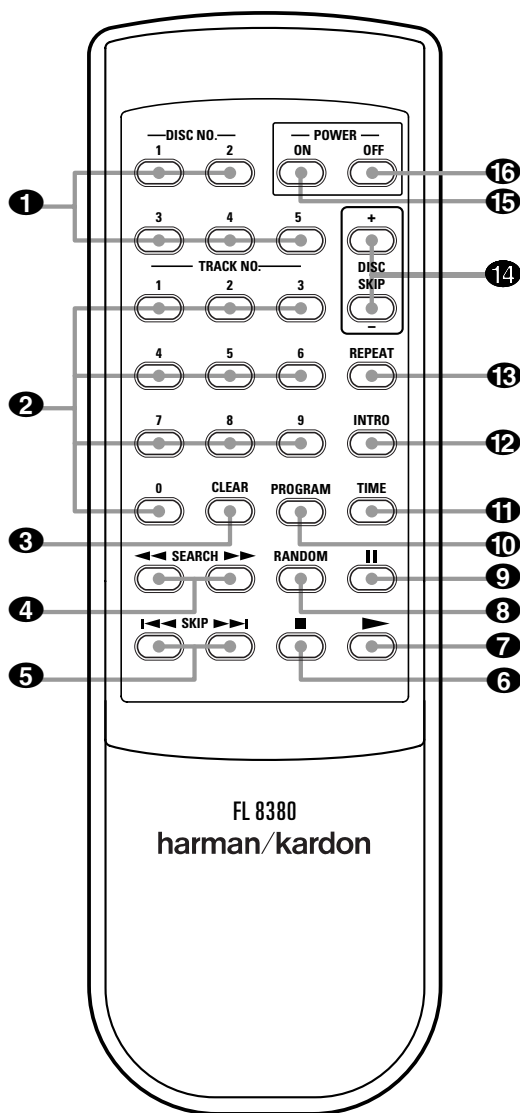

- 1 Disc-Select
- 2 Numeric Buttons
- 3 Clear
- 4 Search
- 5 Skip
- 6 Stop
- 7 Play
- 8 Random
- 9 Pause
- 10 Program
- 11 Time
- 12 Intro
- 13 Repeat
- 14 Disc-Skip
- 15 Power On
- 16 Power Off

Remote Control Functions

- 1 Disc-Select:** Press one of these buttons to select the disc in a specific position in the CD drawer.
- 2 Numeric Buttons:** Press these buttons to select a specific track on a disc. The FL 8380 will immediately go to the track and begin to play it. These buttons are also used to enter track numbers into the memory for preprogrammed-play lists. (See page 13 for complete information on programming the FL 8380.)
- 3 Clear:** Press this button to remove tracks from a programmed sequence. Each press of the button will remove one track, starting with the last track programmed to play. (See page 13 for complete information on programming the FL 8380.)
- 4 Search:** Press these buttons to search forward **▶▶** or backwards **◀◀** through a disc to locate a particular portion of the selection being played.
- 5 Skip:** Press one of these buttons to move to the next track **▶▶▶** or to move back to the previous track **◀◀◀** on the disc being played.
- 6 Stop:** Press this button to stop the disc currently being played.
- 7 Play:** Press this button to start the playback of a CD. If the CD drawer is open, pressing this button will automatically close the drawer.
- 8 Random:** Press this button to play all tracks on one or more CD's in random order. (See page 11 for more information.)
- 9 Pause:** Press this button once to momentarily pause a disc. When the button is pressed again, the disc will resume play from the point at which it was paused.
- 10 Program:** This button is used to program the playback of discs and tracks in a particular order. (See page 13 for complete instructions on programming the FL 8380.)
- 11 Time:** In normal operation, the display will show the running time of the track being played. Press the button once to check the time remaining for the track in play. Press the button again to view the total play time remaining for the disc in play.
- 12 Intro:** Press this button to put the FL 8380 into the Intro Scan mode. When you press this button, the unit will play the first 10 seconds of each track on the disc, and then move to the next track. Press the button again to defeat the function and continue full play of the current track. (See page 12 for more information.)
- 13 Repeat:** Press this button once to continuously repeat the track currently being played. Press it a second time to repeat the entire disc and a third time to repeat all discs. (See page 13 for more information.)
- 14 Disc-Skip:** Press these buttons to change to the next or former disc. If a disc position is empty, the FL 8380 will automatically search for the next position that contains a disc unless the disc drawer is open.
- 15 Power On Button:** When the FL 8380 is plugged into an active AC outlet, press this button to turn the unit on. The **Status Mode Indicator 2** will turn green. If the unit is plugged into a switched outlet, power must be applied to the switched outlet in order for the **Power On** button **15** to be effective.
- 16 Power Off Button:** Press this button to turn the unit off; the **Status Mode Indicator 2** will turn amber, indicating that the unit is in a Standby mode.

Installation and Connections

To prevent possible damage to your speakers and other components in your audio system, it is important that ALL components, including the FL 8380 and your receiver or preamp and amplifiers, are turned off and unplugged from their AC power source when installing any new component.

Connecting the FL 8380 to your audio system is simple. Using standard RCA-to-RCA interconnect cords, connect the left and right **Audio Output** jacks ⑤ on the rear panel to the CD input jacks on your receiver, surround processor or preamplifier.

If your system includes an optional external digital-to-analog converter, or if you are using a receiver or other processor that has the capability to decode PCM digital input signals, connect the **Coaxial Digital Output** jack ② to the Coaxial Digital input on the decoder. Make certain to use a coaxial-style interconnect cable, as standard audio cables will not perform as well.

Install two AA batteries by turning the remote over so that you are holding the bottom side up. Press lightly on the embossed arrow on the cover and gently slide the cover towards you in the direction of the arrow. Insert the batteries inside the compartment, being careful to follow the + and – polarity indications at the bottom of the compartment. Replace the cover by placing it on the remote and sliding it back towards the top of the remote.

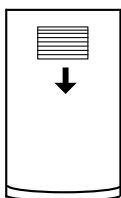
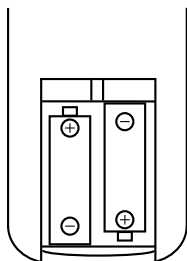
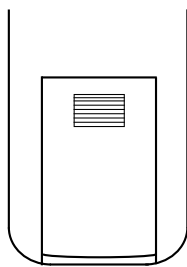

NOTE: When replacing batteries, always replace both at the same time. When the unit will not be used for an extended period of time, it is also a good idea to remove the batteries so that the potential for corrosion or damage is avoided.

If the FL 8380 is installed behind a cabinet or other obstruction that may block the path between the front-panel **Remote Sensor** ⑭ and the location of the remote, an optional external IR sensor may be used. Connect the sensor to the **Remote IR-In Jack** ④ on the rear panel. This jack may also be connected to the IR-Output jack of another compatible Harman Kardon component or a compatible IR-system- remote product.

You may also use the IR Sensor in the FL 8380 to send commands to other compatible remote controlled products. Connect the **Remote IR-Out jack** ③ to the input of the other product or system.

Connect the power to a nonswitched AC wall outlet or to the accessory outlet on the rear of another audio device in your system and you are ready to go!

NOTE: When using the accessory outlet on another product to power the FL 8380 make certain that it has the compatibility to power a device that draws at least 20 watts of current in addition to being able to handle the requirements of the other devices that may be plugged into the accessory outlets. If you use a "switched" outlet, it is important to remember that the host product must be turned on in order for the FL 8380 to operate.

Operation

Loading Discs

To load a disc, first turn the FL 8380 on, using the **Standby Switch** **1**, or the **Power On** **15** button on the remote. Note that the **Status-Mode Indicator** **2** will turn green and the **Information Display** **13** will illuminate. The word **d i s c** will flash in the Information Display, and the disc tray will automatically turn clockwise so that the FL 8380 can sense which, if any, of the disc positions already have a disc.

To load a disc, first press the **Open/Close** button **6**, taking care to make certain that the space in front of the drawer is not obstructed. Note that if the drawer is blocked when you attempt to open it, it will automatically close within five seconds to protect the mechanism.

Load discs in the tray with the printed (label) side facing up toward you. Make certain that the disc is centered in the tray. Either 12cm (5") or 8cm (3") discs may be used. When a 8cm (3") disc is played, it should be carefully centered within the smaller ridges on the tray. Only one CD can be placed in any position at a time. When a 8cm (3") disc is played, DO NOT place a standard 12cm (5") disc over the smaller disc.

Labeled surface

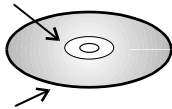

Recorded surface

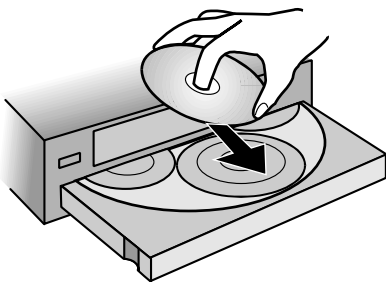

Note that each disc position has a number embossed in the plastic tray. This corresponds to the position this disc will occupy for playback and programming. To make it easier to identify each disc's position, the disc position number for the holder space that is in the center of the disc tray will also appear in the Information Display when the disc drawer is open.

To rotate the disc tray to another position, press the **Disc-Skip** button **11** **14**. The tray will revolve to the next slot and the Information Display will indicate the position number for the slot in the middle of the tray.

To close the disc drawer, press the **Open/Close** button **6**. When the drawer closes all trays will be checked for discs and the disc that was last in the center position on the tray will be readied for play. Its number will appear in the Information Display and a red icon will light to the right of the disc number. The numbers for all other tray positions that have a disc will also light in the upper part of the display. If the center disc position is empty when the drawer is closed, the unit will search for the next position with a loaded disc, and place it in the ready mode.

The drawer may also be closed and the FL 8380 put into play by pressing the **Play/Pause** button **10** **7**. This will put the disc in the center position into the Play mode.

To close the drawer and play a specific disc, press the **Disc Select** button **12** **1** corresponding to the tray position number for the disc you wish to play.

When the disc drawer is closed, the Information Display will display the number of the disc selected, the total number of tracks on the disc and the disc's total running time. In the upper area of the display the numbers of all loaded trays will be shown, with a red icon to the right of the selected disc's number. The total number of tracks on the disc selected will illuminate at the far right side of the display.



To remove a disc from the player, press the **Open/Close** button **6**. The drawer will open, allowing the disc to be removed. Press the **Disc-Skip** button **11** **14** to rotate the disc carousel tray to reach discs that may be covered.

Upon placing a disc in a tray, the disc number will appear when detected by the sensor mechanism after the drawer has closed.

Disc Handling Notes

When loading or unloading discs, it is best to hold them by the edges.

While compact discs are very reliable, rough handling may damage them. Avoid scratching the bottom (nonprinted) side of discs, and any handling that will leave fingerprints.

To avoid damage to the disc and player, always seat discs so that they are centered in the tray.

Do not lift the player while the disc tray is opening or closing, as this may cause the discs to unseat from the tray and possibly jam.

Note: Always remember to remove all discs from the player before moving or repacking it.

Operation

Normal Play

The FL 8380 provides a variety of ways to select discs for playback.

To play all of the tracks on each disc in order, starting with the first track on the disc currently in the play position, and proceeding through each disc that has been loaded, press the **Play/Pause** button **10** on the front panel, or the **Play** **7** button on the remote.

To start play on a specific disc, press the **Disc-Select** button **12** **1** that corresponds to the desired disc's position in the disc tray.

When a disc is in play, the Information Display will show a play indication ►. The track being played will show both as a large number in the middle of the display and as a smaller, flashing number at the right side of the display. The elapsed time of the track being played will appear in the display.

As the disc plays, the track numbers will change, and the time will reset to $\square\square:\square\square$ at the start of each new track. To momentarily pause the play of a disc, press the **Play/Pause** button **10** on the front panel, or the **Pause** **9** button on the remote. Note that a Pause indication **||** will appear in the display to remind you that the disc is paused. Press either the **Play** button (**Play/Pause** on front panel) **10** **7** or the **Pause** button **9** to resume normal play.

You may also select a track on the disc in play by entering the desired track number directly using the **Numeric** buttons **2**. You can always select a track by pressing the two-digit number corresponding to the number of the track. Both digits must be pressed within 5 seconds. For track 1-9, press "0" followed by the track number.

Note: If the CD has less than 10 tracks, it is not necessary to press "0" first. If the CD has between 10 and 19 tracks, it is only necessary to press "0" first when selecting track 1. If the CD has between 20 and 29 tracks, it is only necessary to press "0" first when selecting track 1 or 2.

In short, you only need to press "0" first, if there are two-digit track numbers on the CD which begin with the same number as the single-digit track number that you wish to play.

To stop the disc, press the **Stop** button **9** **6**. When the stop button is pressed the display will again show the total number of tracks and total running time of the last disc played.

Random Play

The FL 8380 includes three random play modes that enable you to let the machine select the tracks to be played in random order. The random modes may be started at any time by pressing **Random** **8** when the unit is already in Play mode or by pressing **Play** **10** after **Random** **8** when it is in Stop mode.

Random 1: To play all the tracks on the current disc in random order, press the **Random** button **8** once so that the **RANDOM** indicator illuminates. The FL 8380 will play the tracks on the disc in an order selected by the unit's micro-processor and stop play when all of the tracks have been played once.

Random, All, Sequential: When the **Random** button **8** is pressed twice, the **RANDOM** and **SEQUENTIAL** indicators will illuminate. In this mode, all tracks on the current disc will be played in random order, and then the unit will advance to the next disc in order and play all tracks on that disc randomly. When each disc is finished the next disc will play its tracks in random order until all discs have been played. After the last disc plays, the unit will stop.

Random, All Tracks/Discs: When the **Random** button **8** is pressed three times, the **RANDOM, ALL** and **DISC** indicators will illuminate. In this mode, the FL 8380 will select two tracks randomly from the disc in use and play them. After these two tracks play, another disc will be randomly selected and two tracks will play from that disc. This pattern of a randomly selected disc, and the play of two random tracks from each disc, will continue until all tracks on all discs have been played. At that point the unit will stop.

 [®], **HDCD** [®]

HDCD, which stands for High Definition Compatible Digital[®], is a sophisticated process that enables the FL 8380 to deliver outstanding digital-to-analog decoding no matter what type of CD is played.

When a disc with the HDCD logo is played, the FL 8380 is able to take advantage of the special recording process that is used in the creation of HDCD discs. Although HDCD discs are playable on any CD player, when they are played on a unit such as the FL 8380, the special circuitry delivers audio with extraordinary fidelity, stunning resolution and the highest possible overall quality. The HDCD process effectively cancels the additive distortions, caused by artifacts of the A/D and D/A conversion processes, and simultaneously provides additional data to reduce the subtractive distortions resulting from insufficient data present in the 44.1 kHz, 16-bit PCM sampling standard of the compact disc format.

No special adjustment is required to play an HDCD disc. Simply play the disc as you would any other CD, and the FL 8380 will automatically sense that it is an HDCD recording. The **HDCD** indicator will light in the **Information Display** **13** on the front panel to remind you that an HDCD disc is playing.

It is important to note that the HDCD process is completely compatible with standard recordings. Its high-quality digital-to-analog circuitry provides enhanced playback even from all standard CD audio discs

Play Exchange

The FL 8380's Play Exchange feature allows you to change discs while the machine is playing. Using this feature, you can have uninterrupted play of an unlimited number of discs, since the drawer may be opened and discs changed while another disc is playing.

To use the Play Exchange function, simply press the **Open/Close** button **6** at any time while the unit is in the Play mode. The disc drawer will open and two discs will be available for change. Replace either disc, or both, as desired. To reach the other two discs, press the **Disc-Skip** button **11** **14**. You may now remove and change either of these two discs.

When you have finished making any disc changes, press the **Open/Close** button **6**. The drawer will close and play will continue with normal functions.

Operation

Time Display

The FL 8380's time display is capable of showing a wide range of information about a CD.

In normal operation the display will show the running time of the track that is currently being played. Each time the track changes, the time display will reset to $\square\square:\square\square$ and begin to increase again as the disc plays.

To view the time remaining on an individual track, press the **Time** button **11** on the remote control ONCE. The display will now show the time left in the track currently playing.

To view the total playing time remaining on a disc, press the **Time** button **11** on the remote control TWICE. In this Time Display mode the **TRACK** indicator will show the tracks remaining, differing from the usual display of the track being played.

Headphone Listening

You may listen to the output of the FL 8380 through headphones by plugging any headphones with a 6,3 mm standard plug or adapter into the front-panel **Headphones Jack** **3**. The volume of the headphone output can be adjusted with the **Headphones Level Control** **4**. Note that changing the headphone level will not change the volume for the main audio output. This is a fixed output and it is changed using the volume control on your receiver, preamplifier or surround processor.

Search

If you wish to quickly scan through a disc to locate a particular passage or program, press the **Search** buttons **7** **4**. The **Forward-Search** button **▶▶** plays the disc forward at high speed, while the **Reverse-Search** button **◀◀** plays the disc backwards at high speed. The front panel features a single **Search** button **7**; press the right side for forward search **▶▶**, or the left side for reverse search **◀◀**. The forward and reverse search functions may also be performed using the separate **Search** buttons **4** on the remote. When the desired part of the disc is heard, release the **Search** button to resume normal play speed.

Skip

To move from one track on a disc to another, press one of the **Skip** buttons **8** **5**. Pressing the **Forward-Skip** button **▶▶|** will move you forwards through the disc one track at a time, while pressing the **Reverse-Skip** button **|◀◀** will move you back to the start of the current track and, if pressed again within two seconds, back one track at a time. Holding any of the buttons pressed, will fastly skip through all tracks. The front panel features a single **Skip** button **8**; press the right side for **Forward Skip** **▶▶|**, or the left side for **Reverse Skip** **|◀◀**. The forward and reverse skip functions can be performed using separate **Skip** buttons **5** on the remote.

The Skip buttons may be used when the FL 8380 is either playing or stopped. If the unit is stopped, the Skip buttons may be used to locate the first track to be played. The **Play** button **7** (**Play/Pause** on the front panel **10**) must be pressed to begin play. If the Skip buttons are used while the unit is already playing, the audio output will stop while the new track is located, and play will automatically resume after the Skip button is released.

Intro Search

This feature lets you locate a track by playing the first 10 seconds of each track. When the **Intro** button **12** on the remote control is pressed, the unit will play only 10 seconds of each track and then automatically move to the next track. When you have reached a track that you wish to listen to in its entirety, press the **Intro** button **12** again to resume normal operation. When the Intro feature is activated, the **INTRO** indicator will illuminate in the **Information Display** **13** to remind you that Intro Search is in use.

When the Intro button is pressed, the FL 8380 will first play through the disc that is currently in the play position and then move on to each disc position that is loaded.

Programmed-Play Operation

The FL 8380's advanced programming capability enables you to preset specific tracks of any CD and the order in which tracks play, repeat specific discs or tracks or repeat all discs and tracks.

Programmed Play

Programmed play allows you to program up to 32 tracks (from one or more CD's) or complete-disc play-through into the FL 8380's memory. To begin programming the FL 8380, press the **Program** button **10** on the remote control. The **PROGRAM** indicator will light in the **Information Display 13**.

You may now begin to enter the discs and tracks in the order in which you wish to have them play. Once the **PROGRAM** indicator is lit, **P - 0 1** will appear in the Information Display, replacing the track time. This indicates that you are about to program the first track.

Press the **Disc-Select** button **12 1** to choose the first disc to be programmed (unless you choose the current disc), and note that **AL** will flash in the Information Display. To have all tracks on the disc play in order as the first program step, press the **Program** button **10** again. To select a single track on the disc, press the **Numeric** buttons **2** corresponding to the desired track (see page 10 how track numbers must be entered). You may also use the **Skip** buttons **8 5** to select a track. When the disc and track are selected, press the **Program** button **10**. Note that the program-step indication on the right side of the Information Display will change to **P - 0 2**.

You may now select another disc and/or track for the next program step, following the instruction shown above. When the program step is selected, press the **Program** button **10**. Repeat this procedure for each program step until you have completed the desired programming. Press the **Stop** button **9 6** once to complete a program sequence, or press **Play 7 (Play/Pause 10)** on the front panel) to begin immediate play of a program sequence. If the maximum of 32 program steps is reached, the program-step indication at the right side of the Information Display will go out, and the disc and track that have been programmed as the first program step will be shown.

Once a program list has been entered, press the **Play** button **7 (Play/Pause 10)** on the front panel) to begin listening to the sequence. After the entire program has been played, the FL 8380 will stop. As long as the **Stop** button **9 6** has not been pressed twice and the **PROGRAM** indicator remains lit, you may repeat the programmed-play sequence again by pressing the **Play** button **7 (Play/Pause 10)** on the front panel).

Pressing **Stop** button **9 6** twice will return to normal mode and the **PROGRAM** indicator will delete, but the program will stay in memory and can be recalled easily by pressing the **Program 10** button. But pressing the **Clear** button **3** (see below), opening the disc drawer by pressing **Open/Close 6**, or turning the FL 8380 off will erase the program information from the unit's memory.

Checking Program Contents

To check the contents of a program while the unit is stopped at first note that the **PROGRAM** indicator is lit (otherwise press **Program 10**) and the program step indication **P - 0 1** is not lit (otherwise press **Stop 6** once). Each time you press the **Skip** buttons **8 5** the Information Display will step through each of the programmed discs and tracks.

Clearing Programs

To clear a single track from the program list, press the **Program** button **10** on the remote until the track to be deleted from the program sequence appears in the **Information Display 13**. When the track number appears, press the **Clear 3** on the remote once, then **Stop 6**, the track selected will be deleted from the title calendar at the right of the display. Now you can press the **Program 10** to select other items to be deleted.

When the unit is stopped and the program step indication **P - 0 1** is not lit (otherwise press **Stop 6** once), but the **PROGRAM** indicator is still lit, you may clear the entire contents of a program by pressing the **Clear** button **3**.

Repeat Play

The FL 8380's programming system enables you to repeat all of the tracks on all of the discs, a complete single disc, or a single track.

Repeat Track Play

To repeat a single track, press the **Repeat** button **13** on the remote control while the desired track is playing so that the **REPEAT** and **1** indicators are lit. The Repeat Track mode may also be activated while the unit is stopped by selecting the desired track using the **Disc-Select** buttons **12 1** and then the **Skip** buttons **8 5** or the **Numeric** buttons **2** as outlined on page 11. When the track is chosen, press the **Repeat** button **13** on the remote control and the **Play** button **7 (Play/Pause 10)** on the front panel). The track will play until the **Stop** button **9 6** is pressed.

Repeat Disc Play

To repeat an entire disc, press the **Repeat** button **13** twice so that the **REPEAT** and **DISC** indicators are lit. Press the appropriate **Disc Select** button **12 1**, the desired disc's icon lights and the disc number appears in the **Information Display 13**. The selected disc will play through to the end and then continue to repeat until the **Stop** button **9 6** is pressed.

Repeat All Discs

To repeat all of the discs that have been loaded into the FL 8380, press the **Repeat** button **13** three times so that the **REPEAT**, **ALL** and **DISC** indicators are lit. Press the **Play** button **7 (Play/Pause 10)** on the front panel) and the unit will play all tracks on all discs, starting with the disc that has been loaded in the play position. When all discs have played through, the sequence will repeat and the discs will continue to play until the **Stop** button **9 6** is pressed.

NOTE: You may cancel a repeat function any time by pressing the **Repeat** button **13** until the **REPEAT** indicators go out. The player will continue with normal play.

IMPORTANT Note: Tracks programmed as described above in chapter "Programmed Play" can be repeated too: When you press **Repeat 13** once after a program is created (the **PROGRAM** indicator must be lit, (otherwise press **Program 10**) and the program step indication **P - 0 1** is not lit (otherwise press **Stop 6** once), the **REPEAT 1** indicator will light and the track currently selected or playing will be repeated continuously. If **Repeat** is pressed twice **REPEAT ALL** will be displayed, all programmed tracks on all discs will be played subsequently and the sequence will be repeated continuously until **Stop 6** is pressed.

Troubleshooting Guide

SYMPTOM	POSSIBLE CAUSE	SOLUTION
No lights on front panel	<ul style="list-style-type: none">• No AC power	<ul style="list-style-type: none">• Make certain that the AC power cord is plugged into a live outlet
Remote does not appear to operate	<ul style="list-style-type: none">• Weak batteries• Blocked sensor	<ul style="list-style-type: none">• Install fresh batteries, observing polarity indications• Remove obstructions from the front-panel sensor, or connect a remote sensor to the Remote-In jack on the rear panel
Front panel lights but CD does not play	<ul style="list-style-type: none">• Disc upside down• Moisture inside unit	<ul style="list-style-type: none">• Turn CD over so that label side faces up• Leave the unit turned ON for 30 minutes to allow moisture to evaporate
Play indicator lights but no sound is heard	<ul style="list-style-type: none">• Receiver or preamp and amp not turned on• Poor connections• Wrong source selected	<ul style="list-style-type: none">• Turn on all necessary equipment• Make sure certain connections are secure and made to the correct (e.g., CD) input• Select CD source on receiver or preamp
Sound skips or stutters during play	<ul style="list-style-type: none">• Disc may be damaged• Surface vibrations	<ul style="list-style-type: none">• Try another disc• Isolate the unit from vibration by placing it on a firm surface or move it further away from speakers
Sound is continually distorted	<ul style="list-style-type: none">• Incorrect input	<ul style="list-style-type: none">• Make certain that the Analog Audio Outputs 5 of the FL 8380 are connected to a line-level audio input, NOT to a digital audio or phono input

Technical Specifications

Signal Format

Sampling Frequency	44.1kHz
HD/CD Processing	Burr Brown PCM1732
D/A Conversion	up to 24 Bit/96 kHz
Oversampling	8 Times

Discrete Analog Output Section

Error Correction	CIRC System
Frequency Response	20 Hz – 20 kHz +0/-1dB
Total Harmonic Distortion (THD)	<0.008% @1kHz
Dynamic Range	>97 dB
Signal-to-Noise Ratio	>100 dB
Channel Separation	80 dB
Line-Output Level	2.0V RMS
Digital Output	Coax

General

Power Requirement	AC 230/50 Hz
Power Consumption	14 Watts (max)
Dimensions	
Height	129mm (5.1")
Width	440mm (17.3")
Depth	386mm (15.2")
Weight	7.6 kg (16.7 lbs.)

Depth measurement includes knobs and buttons.

Height measurement includes feet and chassis.

All features and specifications are subject to change without notice.

Harman Kardon is a registered trademark, and Power for the digital revolution is a trademark, of Harman Kardon, Inc.

 HD/CD®, High Definition Compatible Digital® and Pacific Microsonics™ are either registered trademarks or trademarks of Pacific Microsonics, Inc., in the United States and/or other countries. HD/CD system manufactured under license from Pacific Microsonics, Inc. This product is covered by one or more of the following: In the USA: 5,479,168; 5,638,074; 5,640,161; 5,808,574; 5,838,274; 5,854,600; 5,864,311; 5,872,531; and in Australia: 669114. Other patents pending.

harman/kardon

H A Harman International Company
250 Crossways Park Drive, Woodbury, New York 11797
www.harmankardon.com
Harman Consumer International:
2, route de Tours, 72500 Château-du-Loir, France
© 2000 Harman Kardon, Incorporated
Part No. 5100-837000-100